

Dewatering Pumps

HD/HDG/BD

60Hz
SERIES



HD

FEATURES

- Compact, robust and easy handling for all construction and civil engineering dewatering application conditions.
- Stainless steel (SUS304) outer casing, the self-cooling motor is suitable for continuous duty and low water level conditions.
- Standard accessories include the cable with an epoxy resin sealed water-resistant cable base, Auto-cut motor protector, double mechanical seals, oil seal design, and High Solid Epoxy coating.
- High efficient special impeller design in High Chrome Alloy steel (HiCrFC), with a hardness of 55 - 60 Rockwell, to stand high abrasive applications.
- The pump internal castings are all protected by the high solids epoxy coating, which can prolong the metal life and avoid corrosion and oxidation.
- The mechanical seal bracket is covered by EPDM with anti-abrasive wear for HD 15~20HP models.
- Optional ADTC (Adapter Connection) Casing to connect suction with inline pipe, allowing surface/inline/deep well pumping.

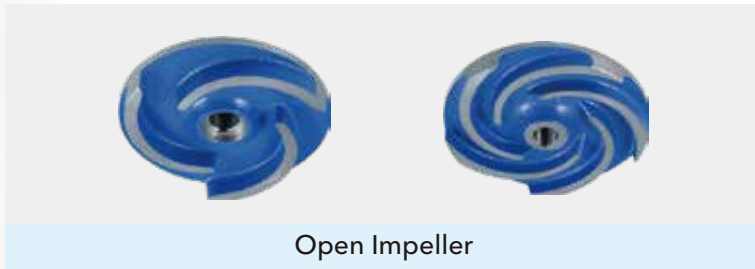

APPLICATIONS

- Civil engineering, dewatering, tunneling, groundworks, mining, and manhole sewer.
- Industrial wastewater dewatering of fluids containing solid sediments.
- Portable use for contractors, installers, and industry.

PRODUCT NOMENCLATURE

100	HD	2	5.5
Discharge mm	Type	Pole	kW

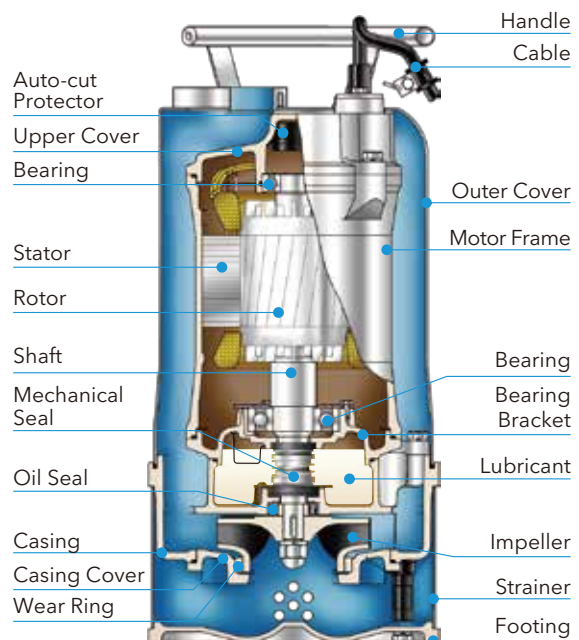



PERFORMANCE CURVES

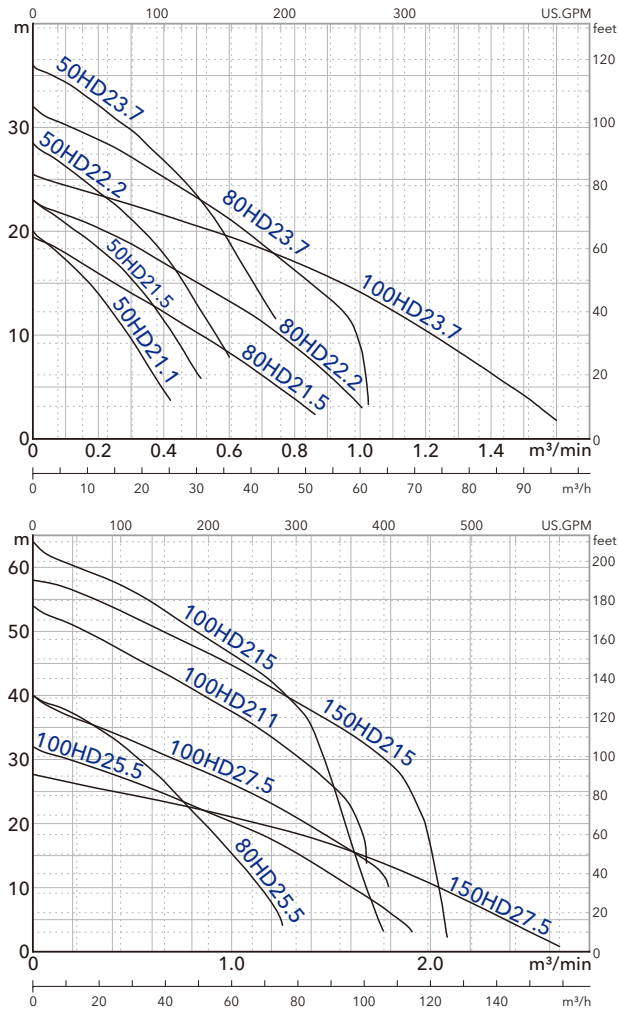

SPECIFICATIONS

Item		Description
Limits of Use	Liquid Temp.	0~40°C (32~104°F)
	Applications	Construction sites • Basins dewatering
Type	Frequency	60Hz
	Motor	2P (3600rpm) • Dry Motor
	Insulation	Class F (1.5~5HP) • Class H (7.5~20HP)
	Protection	IP68
	Protector	Auto-cut
	Bearing	Ball type
	M.seal	Double M.seals
Material	Impeller	Open • Close
	Outer Cover	SUS304 / AISI 304
	Upper Cover	FC200 / ASTM-30
	Motor Frame	SUS304 / AISI 304 (1.5HP) • FC200 / ASTM-30 (2~20HP)
	Shaft	SUS403 / ASTM 403 (1.5~3HP) • SUS304 / AISI 304 (5~10HP) • SUS420J2 / ASTM 420 F (15~20HP)
	M.seal	CA/CE & SiC/SiC
	Casing	FC200 / ASTM-30 (1.5~10HP) • FCD500 / Gr.65-45-12 (15~20HP)
	Impeller	HiCrFC
	Wear plate	HiCrFC (For Open)
	Wear ring	HiCrFC (For Close)
Cable	VCT or SJOW/SOW	
Optional	Pumps can be customized to fit specifications Floating Switch (1.5~3HP 1Ø)	

PERFORMANCE SPECS.

※ Note : Weight Without Cable & Outlet.

Model	Output HP(kW)	Discharge Inch(mm)	Phase	Start Method	Standard		Solid Passage mm(inch)	Weight kg(lb)		Dimensions mm				
					m-m³/min	ft-GPM		1Ø	3Ø	A	1Ø	3Ø	1Ø	3Ø
50HD21.1	1.5(1.1)	2"(50)	1/3	Capacitor DOL	13.5-0.2	44-52	7.5(1/4")	28(62)	24(53)	210	482	423	431	372
50HD21.5	2(1.5)	2"(50)	1/3	Capacitor DOL	16.5-0.25	54-66	10(3/8")	40(88)	36(79)	235	511	466	465	421
50HD22.2	3(2.2)	2"(50)	1/3	Capacitor DOL	20.5-0.3	67-80	10(3/8")	44(97)	39(86)	235	541	466	496	421
50HD23.7	5(3.7)	2"(50)	3	DOL	29.5-0.3	96.8-80	10(3/8")	-	44(97)	235	-	496	-	451
80HD21.5	2(1.5)	3"(80)	1/3	Capacitor DOL	10-0.5	33-132	10(3/8")	40(88)	36(79)	235	511	466	465	421
80HD22.2	3(2.2)	3"(80)	1/3	Capacitor DOL	15-0.5	49-132	10(3/8")	44(97)	39(86)	235	541	466	496	421
80HD23.7	5(3.7)	3"(80)	3	DOL	22.5-0.5	73.8-132	10(3/8")	-	44(97)	235	-	496	-	451
100HD23.7	5(3.7)	4"(100)	3	DOL	13-1.0	42.7-264	10(3/8")	-	44(97)	235	-	511	-	465
80HD25.5	7.5(5.5)	3"(80)	3	DOL	30-0.5	98-132	10(3/8")	-	69(152)	286	-	610	-	550
100HD25.5	7.5(5.5)	4"(100)	3	DOL	20-1.0	66-264	10(3/8")	-	71(157)	286	-	610	-	550
100HD27.5	10(7.5)	4"(100)	3	DOL	26-1.0	85.3-264	10(3/8")	-	79(174)	286	-	610	-	550
150HD27.5	10(7.5)	6"(150)	3	DOL	17-1.5	55.8-395	10(3/8")	-	81(179)	286	-	610	-	550
100HD211	15(11)	4"(100)	3	DOL	37-1.0	121-264	10(3/8")	-	124(273)	330	-	700	-	642
100HD215	20(15)	4"(100)	3	DOL	46-1.0	151-264	10(3/8")	-	133(293)	330	-	700	-	642
150HD215	20(15)	6"(150)	3	DOL	35-1.5	115-395	10(3/8")	-	132(291)	330	-	700	-	642

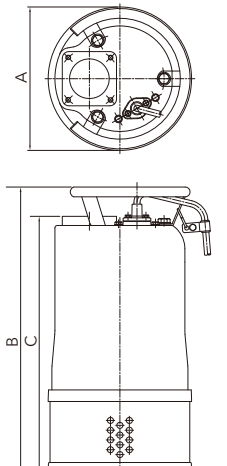



HDG 2-5HP



HDG 7.5-10HP

HDG

FEATURES

- Optimizing HDG series designed with hardened ductile cast iron (FCD-700) agitator, for maximum stirring and pump action for slurry applications.
- Standard accessories include: cable with an epoxy resin sealed water-resistant cable base, Auto-cut motor protector, double mechanical seals, oil seal design, and High Solid Epoxy coating.
- High efficient special impeller design in High Chrome Alloy steel (HiCrFC), with a hardness of 55 - 60 Rockwell, to stand high abrasive applications.



Open Impeller

Close Impeller

Agitator

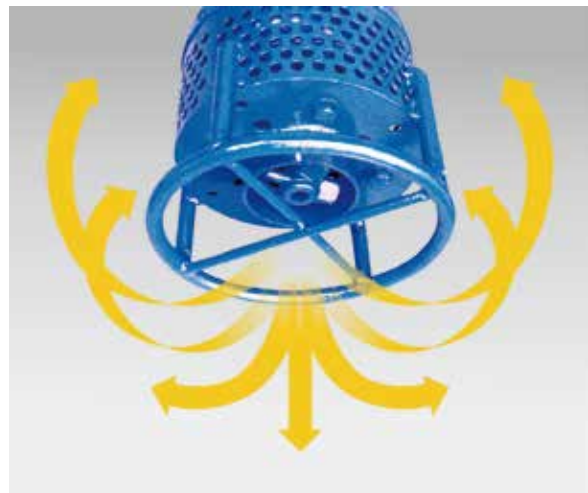

APPLICATIONS

- Civil engineering, dewatering, tunneling, groundworks, mining, and manhole sewer.
- Industrial wastewater dewatering of fluids containing solid sediments.
- Portable use for contractors, installers, and industry.

PRODUCT NOMENCLATURE

80	HDG	2	1.5
Discharge mm	Type	Pole	kW

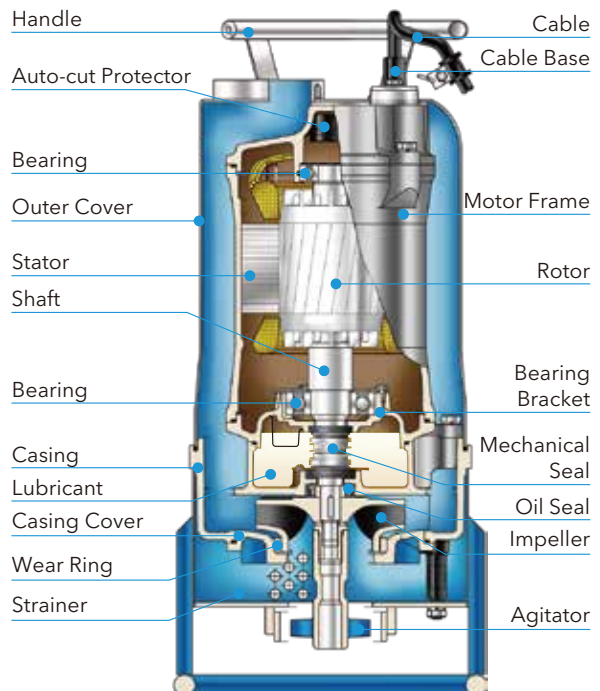

Handle

Cable

Auto-cut Protector

Cable Base

Bearing

Motor Frame

Outer Cover

Rotor

Stator

Shaft

Bearing

Bearing Bracket

Casing

Mechanical Seal

Lubricant

Oil Seal

Casing Cover

Impeller

Wear Ring

Strainer

Agitator



PERFORMANCE CURVES

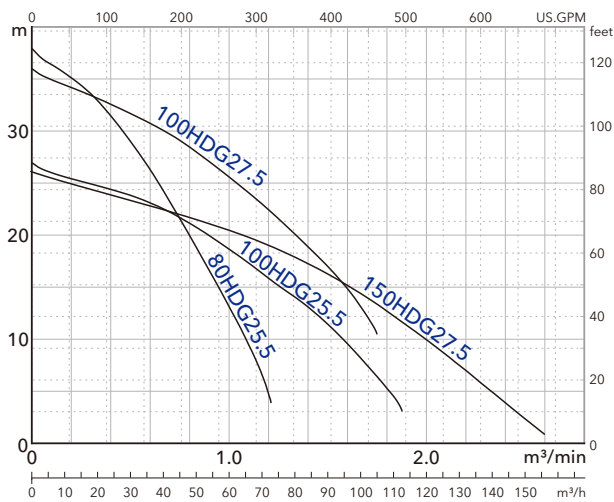
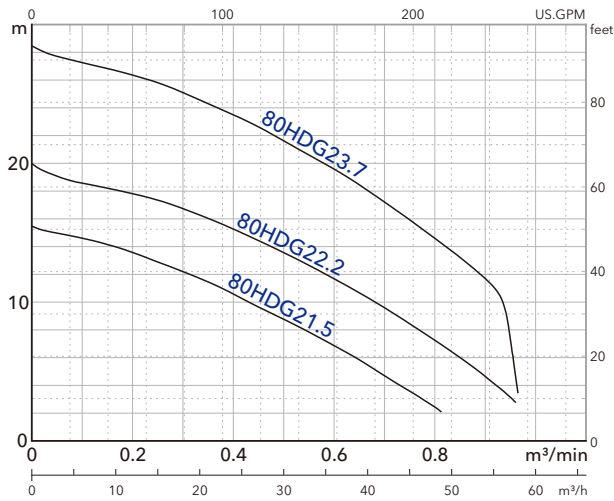

PERFORMANCE SPECS.

Model	Output HP(kW)	Discharge Inch(mm)	Phase Ø	Start Method	Standard		Solid Passage mm(inch)	Weight kg(lb)		Dimensions mm				
					m-m³/min	ft-GPM		1Ø	3Ø	B C				
										1Ø	3Ø	1Ø	3Ø	
80HDG21.5	2(1.5)	3"(80)	1/3	Capacitor DOL	8-0.5	28-132	10(3/8")	41(90)	36(79)	260	592	547	546	502
80HDG22.2	3(2.2)	3"(80)	1/3	Capacitor DOL	13.5-0.5	44-132	10(3/8")	45(99)	39(86)	260	622	547	577	502
80HDG23.7	5(3.7)	3"(80)	3	DOL	21-0.5	68.9-132	10(3/8")	-	45(99)	260	-	577	-	532
80HDG25.5	7.5(5.5)	3"(80)	3	DOL	29-0.5	95-132	10(3/8")	-	70(154)	318	-	683	-	623
100HDG25.5	7.5(5.5)	4"(100)	3	DOL	18-1.0	59-264	10(3/8")	-	72(159)	318	-	683	-	623
100HDG27.5	10(7.5)	4"(100)	3	DOL	25-1.0	82-264	10(3/8")	-	80(176)	318	-	683	-	623
150HDG27.5	10(7.5)	6"(150)	3	DOL	16-1.5	52.5-395	10(3/8")	-	82(181)	318	-	683	-	623

※ Note : Weight Without Cable & Outlet.

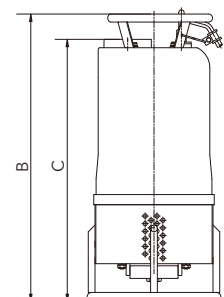
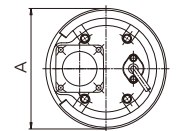

SPECIFICATIONS

Item	Description
Limits of Use	Liquid Temp. 0~40°C (32~104°F)
	Applications Dewatering Fluids Contain Solid Sediment
Type	Frequency 60Hz
	Motor 2P (3600rpm) • Dry Motor
	Insulation Class F (2~5HP) • Class H (7.5~10HP)
	Protection IP68
	Protector Auto-cut
	Bearing Ball type
	M.seal Double M.seals
	Impeller Open • Close
Material	Outer cover SUS304 / AISI 304
	Upper Cover FC200 / ASTM-30
	Motor Frame FC200 / ASTM-30
	Shaft SUS403 / ASTM 403 (2~3HP) • SUS304 / AISI 304 (5~10HP)
	M.seal CA/CE & SiC/SiC
	Casing FC200 / ASTM-30
	Impeller HiCrFC
	Wear plate HiCrFC (For Open)
	Wear ring HiCrFC (For Close)
	Agitator FCD700 / Gr.100-70-03
Cable VCT or SJOW/SOW	
Optional	Pumps can be customized to fit specifications



BD 30HP



ADTC

BD

FEATURES

- Compact, robust and easy handling for all construction and civil engineering dewatering application conditions.
- SPHC double outer casing, water cooling motor for continuous duty, and low water level conditions.
- High efficient special impeller design in High Chrome Alloy steel (HiCrFC), with a hardness of 55 - 60 Rockwell, to stand high abrasive applications.
- The mechanical seal bracket is covered by EPDM with anti-abrasive wear. The casing is heat-treated nodular cast iron (FCD500) and the wear plate is made of high chrome alloy steel (HiCrFC) to resist the intensive abrasiveness of sand and gravel.
- Standard accessories include the cable with an epoxy resin sealed water-resistant cable base, Auto-cut motor protector, double mechanical seals, oil seal design, and High Solid Epoxy coating.
- Optional ADTC (Adapter Connection) Casing to connect suction with inline pipe, allowing surface/inline/deep well pumping.



Close Impeller

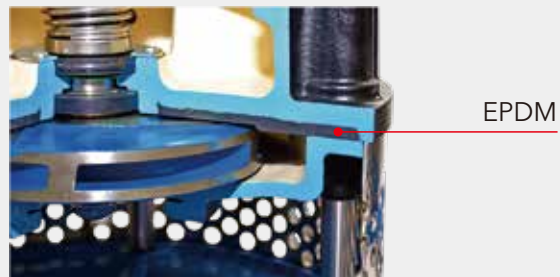

EPDM

APPLICATIONS

- Dewatering for Civil engineering, tunneling, groundworks, mining and manhole sewer, and infrastructure construction, etc.
- River restoration, Dredging ditch drainage.
- Hyporheic flow construction work.
- Cooling water system in steel mill quenching process.

PRODUCT NOMENCLATURE

150(200)	BD	2	22
Discharge mm	Type	Pole	kW

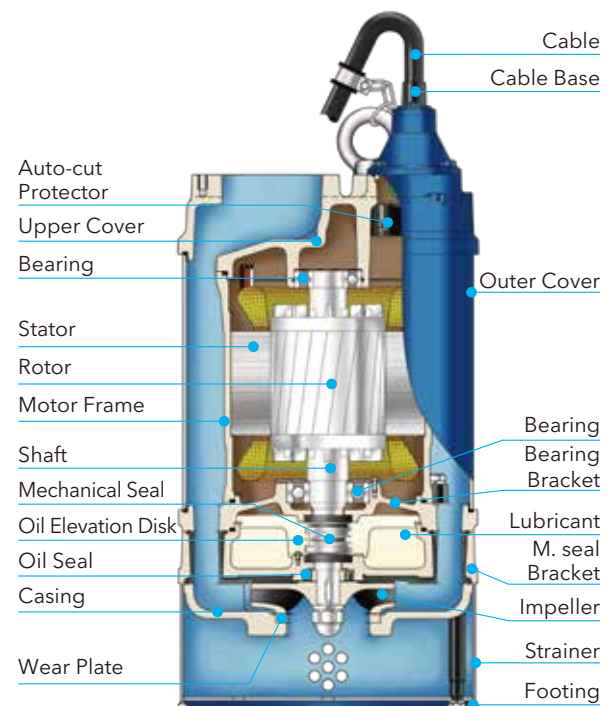



PERFORMANCE CURVES

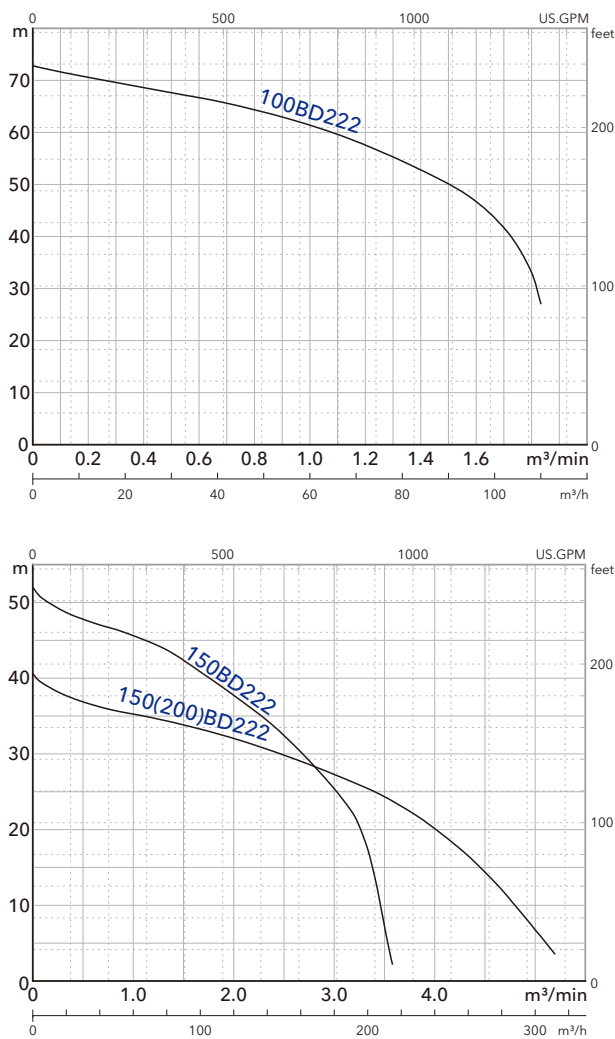

SPECIFICATIONS

Item		Description
Limits of Use	Liquid Temp.	0~40°C (32~104°F)
	Applications	Construction sites • Basins dewatering
Type	Frequency	60Hz
	Motor	2P(3600rpm) • Dry Motor
	Insulation	Class H
	Protection	IP68
	Protector	Auto-cut
	Bearing	Ball type
	M.seal	Double M.seals
	Impeller	Close
Material	Outer cover	SPHC / 620
	Upper Cover	FC200 / ASTM-30
	Motor Frame	FC200 / ASTM-30
	Shaft	SUS420J2 / ASTM 420 F
	M.seal	CA/CE & SiC/SiC
	Casing+ Wear Plate	FCD500 / Gr.65-45-12 + HiCrFC
	Impeller	HiCrFC
	Wear Plate	HiCrFC
	Cable	VCT or SOW
	Optional	Pumps can be customized to fit specifications



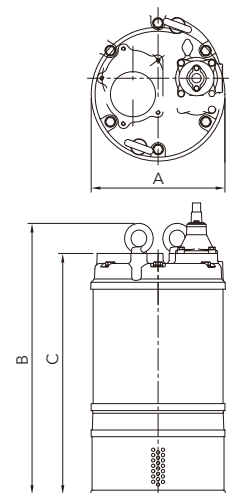

PERFORMANCE SPECS.

Model	Output HP(kW)	Discharge Inch(mm)	Phase Ø	Start Method	Standard		Solid Passage mm(inch)	Weight kg(lb)	Dimensions mm		
					m-m³/min	ft-GPM			A	B	C
100BD222	30(22)	4"(100)	3	DOL	61-1.0	200-264	10 ^(3/8) "	225(496)	403	813	721
150BD222	30(22)	6"(150)	3	DOL	37-2.0	121-530	10 ^(3/8) "	223(492)	403	813	721
150(200)BD222	30(22)	6"(150) 8"(200)	3	DOL	31.5-2.0 20-4.0	103-530 66-1060	20 ^(3/4) "	222(489)	403	813	721

※ Note : Weight Without Cable & Outlet.



OPTIONAL OUTLET SET

Output HP(kW)	Discharge inch(mm)	Lower PCD*Holes	LOH Hose Connection	LOT Male Thread Connection	LOF Flange Connection	LKF Double Flange Set	LOC Center Line Flange
							
2(1.5) 5(3.7)	2"(50)	98*4	LOH2-98	LOT2-98	LOF2-120-125*98	LKF2-120*98	-
	3"(80)	98*4	LOH3-98	LOT3-98	LOF3-150-160*98	LKF3-150*98	LOC3-150*98
	4"(100)	98*4	LOH4-98	LOT4-98	LOF4-175-190*98	LKF4-175*98	-
7.5(5.5) 10(7.5)	3"(80)	127*4	LOH3-127	LOT3-127	LOF3-150-160*127	LKF3-150*127	LOC3-150*127
	4"(100)	127*4	LOH4-127	LOT4-127	LOF4-175-190*127	LKF4-175*127	-
	6"(150)	127*4	LOH6-127	LOT6-127	LOF6-240*127	LKF6-240*127	-
15(11) 20(15)	4"(100)	145*4	LOH4-145	LOT4-145	-	-	LOC4-175*145
	6"(150)	145*4	LOH6-145	LOT6-145	-	-	LOC6-240*145
30(22)	4"(100)	185*5	LOH4-185	LOT4-185	-	-	-
	6"(150)	185*5	LOH6-185	LOT6-185	-	-	LOC6-240*185
	8"(200)	185*5	LOH8-185		-	-	-

※ Pumps require center align could adapt with LOC sets, which can prevent center of gravity(CG) swift under pipe connection, keep dewatering in alignment with pipe arrangement.

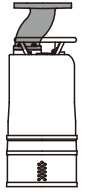

PRODUCT NOMENCLATURE

LOH 4 - 98
Type Discharge PCD

LOF 4 - 175 - 190 * 98
Type Discharge PCD PCD
(upper flange) (lower flange)

ACCESSORIES : ADAPTER

ADTC (Adapter Connection) Pump model, can be applied with flange type adapter or check valve is an optional accessory for groundwater, deep well or wellpoint dewatering applications.



ADT

Adapter Connection (ADTC)

OPTIONAL ADTC (ADAPTER CONNECTION) CASING

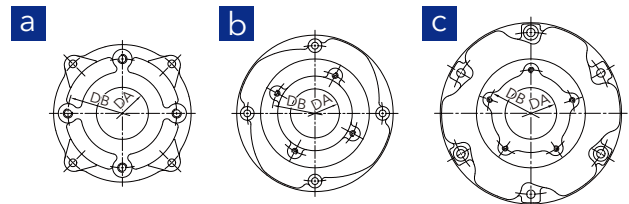

Figure	Model	mm		Bolt Size	Screw Number
		DA	DB		
a	80HD21.5/22.2/23.7	67	140	M12*25L	4
a	100HD23.7	80	150	M12*25L	4
a	100HD25.5/27.5	87	150	M12*25L	4
a	150HD27.5	97	175	M12*25L	4
b	100HD211/215	100	175	M12*30L	4
b	150HD215	100	175	M12*30L	4
b	100BD222	100	175	M12*30L	4
b	150BD222	110	175	M12*35L	4
c	150(200)BD222	120	185	M12*35L	5

PRODUCT FEATURES



Epoxy Cable Base

An epoxy resin seal cable base prevents moisture from entering the motor through the core wires.



Double Mechanical Seals

Superior abrasion resistant mechanical seal is manufactured with silicon carbide to ensure the best seal effect.



Auto-cut Protector

Automatic On/Off motor protector to prevent motor burn out due to high temperature and excess amperage draw. The Protector can revert when the motor temperature returns to normal.



High Efficiency Dry Motors

All stator coils are treated with insulating vanish procedures to achieve the best insulation, efficiency and durability.



Professionalism • Innovation • Service • Commitment
HCP PUMP MANUFACTURER CO., LTD.
www.hcppump.com



Distributor: