



Installed at 1 meter depth



**J** 50Hz  
SERIES

SUBMERSIBLE EJECTOR PUMPS



25JFP2.8

32JNP21.5/22.2  
50JNP23.7

32JPP21.5/22.2/  
50JPP43.7

50JPE45.5

50JPU41.5/42.2/43.7

# J

## FEATURES

- Special Mix Chamber design - Provides maximum air suction and produces the maximum amount of small air bubbles, which increases the rate of oxygen supply.
- High Efficiency Sewage Impeller design - Suitable for most all sewage environments. The Jet pump is equipped with strainer which prevent solids to block water flow.
- Submersible design - The Jet pump runs very quietly while submerged in the water and you can also install the silencer on the air suction pipe to decrease any noise levels. The Jet pump design can save the cost of construction of a silencer room which is required with a surface blower.
- One set of ejector is equipped with one piece of expansion pipe. Expansion pipe is made of PVC which provide good resistance to corrosion.
- Simple Construction - Easy to install and operate, with no need to install complex piping. It can be used with our GRS (guide rail system) for ease of installation and maintenance.

## SPECIFICATIONS

Item		Description
Limits of Use	Liquid Temp.	0~40°C(32~104°F)
	Applications	Waste Water • Sewage • Industrial Waste Water
Type	Frequency	50Hz
	Motor	2P (3000rpm) / 4P(1500rpm) • Dry Motor
	Insulation	Class B (1HP) • Class F (2~5HP) • Class H (7.5~10HP)
	Protection	IP68
	Protector	Auto-cut
	Bearing	Ball type
	M.seal	Double M.seals
	Impeller	Vortex • Open • Channel
Material	Upper Cover	FC200 / GG-20
	Motor Frame	SUS304 / X5CrNi18-10 • FC200 / GG-20 (JP)
	Shaft	SUS410 / X10Cr13 (1HP) • SUS403 / X5Cr13 (2~5HP) • SUS420J2 / X30Cr13 (7.5~10HP)
	M.seal	CA/CE & SiC/SiC
	Casing	FC200 / GG-20
	Impeller	FC200 / GG-20
Aerator	Cable	VCT or H07RN-F
	Air Inlet Chamber	FC200 / GG-20
	Nozzle	SUS304 / X5CrNi18-10
	Diffuser	PVC (1~5HP) • SS400 / ST-44-2 (7.5~10HP)
Optional	Pumps can be customized to fit specifications	

## CONSTRUCTION DESCRIPTION

- The impeller of the submersible Jet pump produces a high volume pressure that forces the fluid to pass through the narrow pipe, which in turn, creates the strong jet fluid current and negative pressure. This created negative pressure, compared with the atmosphere's pressure, is what causes it to pull the air into the mix chamber. The air in the mix room is dashed and pressed into lots of minor bubbles. The minor bubbles mix with the fluid current. The bubbles, under this pressure, continue to mix with the fluid in the expansion pipe and this increases the rate of oxygen supply. After the expansion pipe, the strong fluid current flushes to the outside so it can cause the best function of mix and circulation creating oxygen supply.
- The strainer is installed on the bottom of the Jet pump to help it avoid foreign particles that could clog at the impeller or outlet jet pipe that could cause the condition of a decreased rate of oxygen supply.
- The Jet pump is equipped with the guide rail system for easy installation and removal.

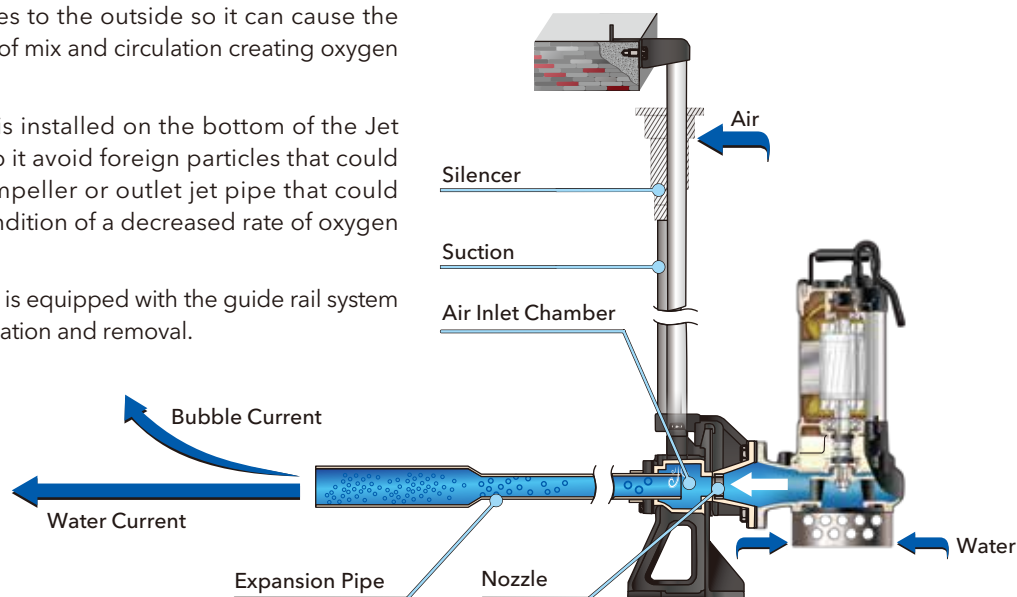



50JPU45.5/47.5



▶ Wastewater treatment:  
installed at 4.5 meter depth



▶ Water circulation and oxygen supply :  
installed at one meter depth

## APPLICATIONS

- Living wastewater, manholes, stock farms, wastewater treatment, supplies the oxygen to a slurry treatment tank.
- To produce the water current in fountain pools or water tanks to help avoid accumulation and decay on the bottom of tank and pool.
- Aquaculture farm, oxygen supply for water tank.

## PRODUCT NOMENCLATURE

32	JN	P	2	2.2
Discharge mm	Type	Impeller type	Pole	kW

## PERFORMANCE CURVES

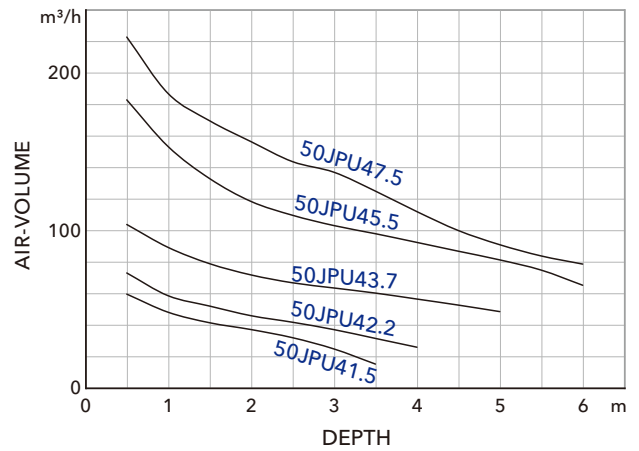
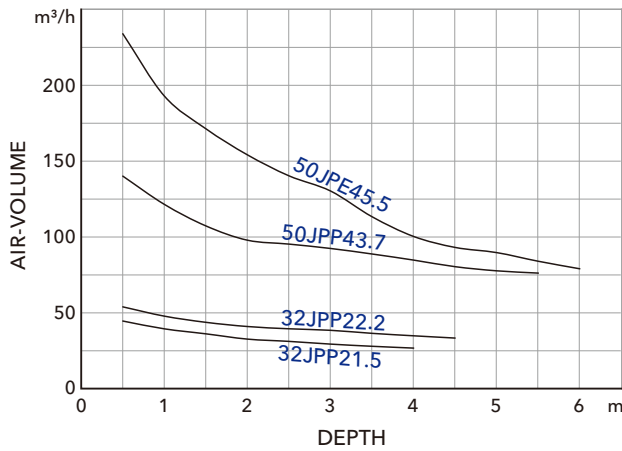
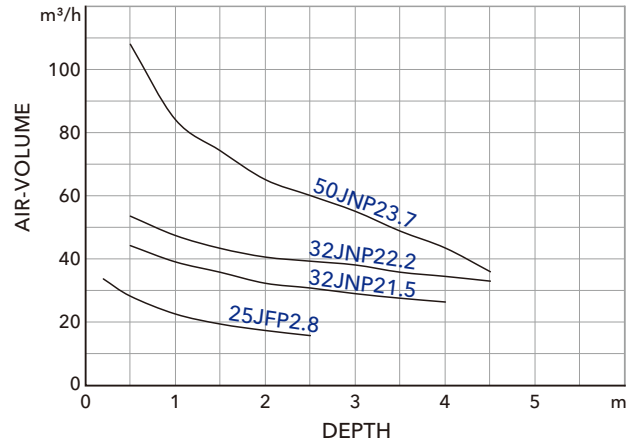

## PERFORMANCE SPECS.

※ Note : Weight Without Cable & Ejector Set. The air flow rates are for reference.

Model	Output HP (kW)	Suction Pipe mm (inch)	Air Volume (Depth) m³/h(m)	Max Depth m	*Capacity m³/h	Solid Passage mm	Weight kg		*Tank Max Dimension m			Accessories		
							1Ø	3Ø	Length	Width	Height	Ejector	GRS	Silencer
25JFP2.8	1(0.75)	25(1")	15.5(2.5)	2.5	21	20	19	18	3	2	3	J-1AP	JT-1AP	JH-1"
32JNP21.5	2(1.5)	32(1.25")	26(3)	4	51	20	34	30	4	3.5	4	J-1¼BP	JT-1¼BP	JH-1¼"
32JNP22.2	3(2.2)	32(1.25")	38(3)	4.5	60	20	37	32	5	5	4.5	J-1¼BP	JT-1¼BP	JH-1¼"
50JNP23.7	5(3.7)	50(2")	55(3)	4.5	78	20	-	35	5	5	4.5	J-2CP	JT-2CP	JH-2"
32JPP21.5	2(1.5)	32(1.25")	26(3)	4	51	20	37	32	4	3.5	4	J-1¼BP	JT-1¼BP	JH-1¼"
32JPP22.2	3(2.2)	32(1.25")	38(3)	4.5	60	20	39	35	5	5	4.5	J-1¼BP	JT-1¼BP	JH-1¼"
50JPP43.7	5(3.7)	50(2")	90(3)	5.5	78	35	-	70	6	6	5.5	J-2CP	JT-2CP	JH-2"
50JPE45.5	7.5(5.5)	50(2")	130(3)	6	132	35	-	112	7	7	6	J-2D	JT-2D	JH-2"
50JPU41.5	2(1.5)	50(2")	22(3)	3.5	37.5	43	46	46	4	3.5	4	J-2CP	JT-2CP	JH-2"
50JPU42.2	3(2.2)	50(2")	35(3)	4	54	43	-	57	5	5	4.5	J-2CP	JT-2CP	JH-2"
50JPU43.7	5(3.7)	50(2")	60(3)	5	84	43	-	66	5	5	5	J-2CP	JT-2CP	JH-2"
50JPU45.5	7.5(5.5)	50(2")	100(3)	6	105	43	-	96	7	7	6	J-2D	JT-2D	JH-2"
50JPU47.5	10(7.5)	50(2")	135(3)	6	138	43	-	105	7	7	6	J-2D	JT-2D	JH-2"



Aquaculture farming : Installed at 1 meter depth

### ACCESSORIES :

#### J - EJECTOR

#### JT - GUIDE RAIL SYSTEM (GRS)

Pump can be installed with J(Ejector) and JT(GRS) for easy and quick installation, maintenance and replacement.

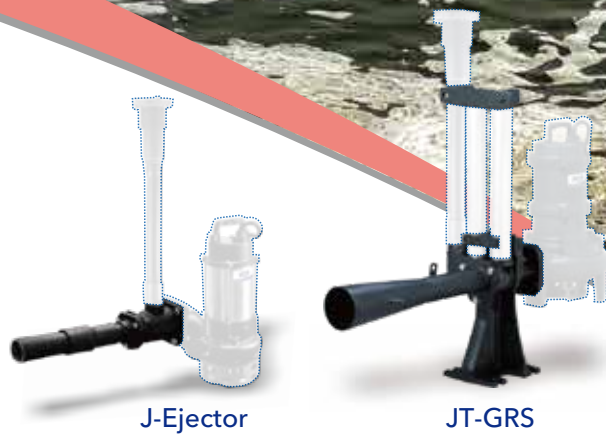

J-Ejector

JT-GRS

### AIR / WATER CURRENT DRAWING

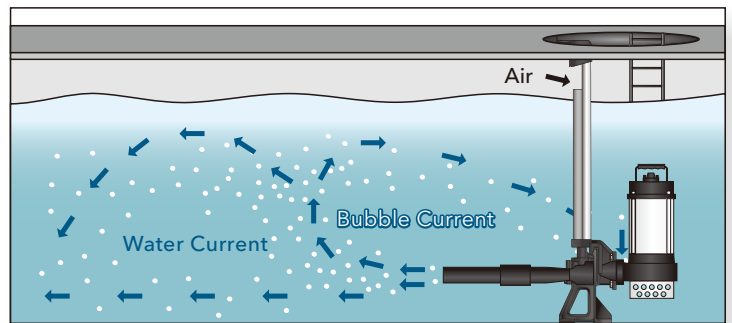
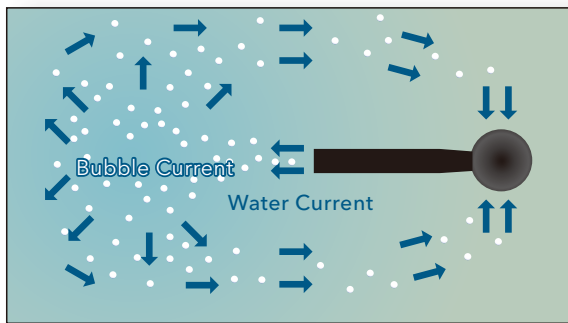

### INSTALLATION DRAWING

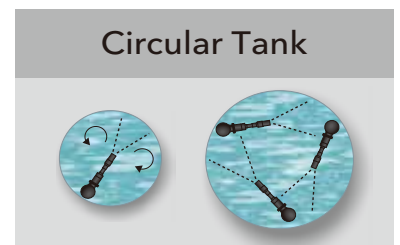
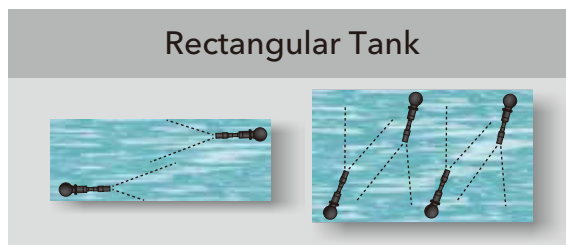
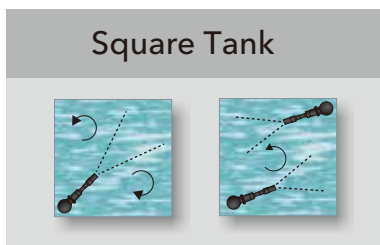

Professionalism · Innovation · Service · Commitment  
**HCP PUMP MANUFACTURER CO., LTD.**  
[www.hcppump.com](http://www.hcppump.com)



Distributor: